

PLAN.

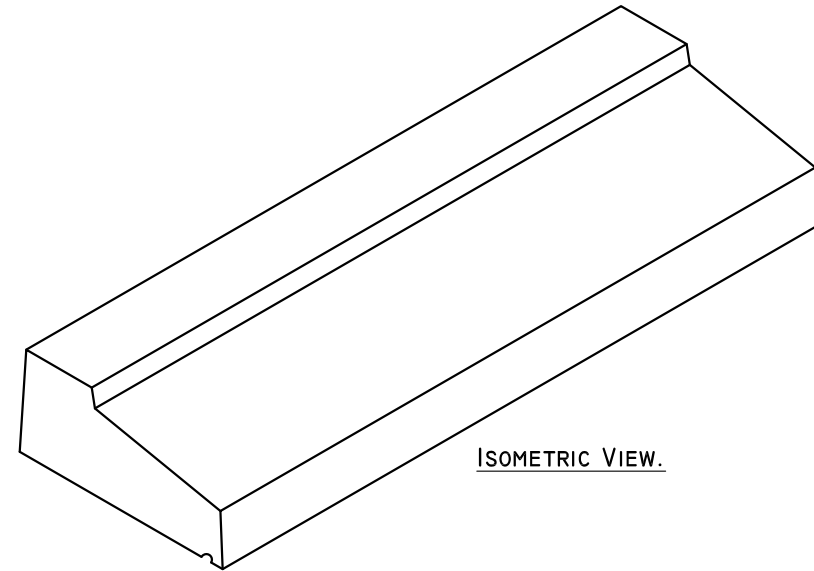

ISOMETRIC VIEW.

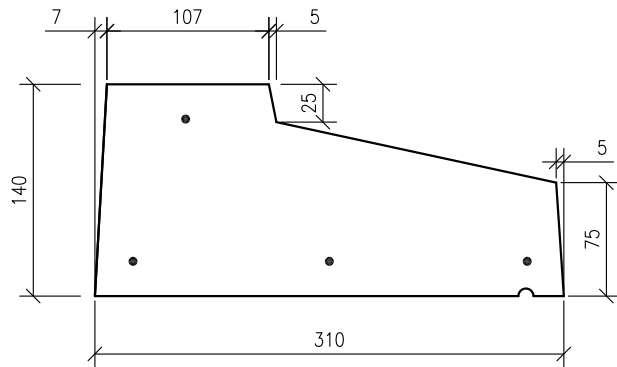

SECTION.

C28/35 concrete @ 28 days with 10mm & 14mm aggregate used in the manufacture of this unit.

Steel reinforcing consists of 4No. R6mm bars with 20mm cover (minimum) & 30mm at ends. Rebar located by patent plastic spacers – 2No per cill under 1200mm long & min 3No otherwise.

Cill complies with IS 89-1: 1981

A. Title block amended.

May 2020

- DO NOT SCALE USE FIGURED DIMENSIONS ONLY.
- ALL DIMENSIONS TO BE CHECKED ON SITE.
- A.P.C TO BE INFORMED OF ANY DISCREPANCIES BEFORE WORK PROCEEDS.

© COPYRIGHT: Ardee Precast Concrete.
This drawing or any part thereof may not be copied or otherwise reproduced without the written permission of Ardee Precast Concrete.

Project:

TECHNICAL DATA SHEET.

Sheet Size:

A4

Title:

**CILLS - TYPE 6.
75MM ON FACE.**

Drawing Scale:

1:10, 1:5

Drawn By:

N.D.

Drawing No:

APC - 505

Revision:

A

Date:

20-02-2018

Checked By:



Ardee Precast Concrete Ltd.

Townparks
Ardee
Co. Louth

Tel. +353(0)41 6856372
Fax. +353(0)41 6857216

Email us at info@ardeeprecastconcrete.ie
Visit us at www.ardeeprecastconcrete.ie